













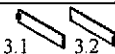







TITANIC FURNITURE

ASSEMBLY INSTRUCTIONS

ITEM NUMBER : B184K / B185K / B186K
DESCRIPTION : Upholstered Bed

Thank you for purchasing this quality product .
Please read instruction carefully prior to assembly.
Check carefully for small part which may have come loose during transportation inside all the boxes.
Remove from boxes and place all parts and components on soft surface such as carpet, blanket or furniture pad. Identify and verify all part and hardware as specified below.

PART LIST :				HARDWARE LIST :				
NO	DESCRIPTION	OUT LOOK	NO	NO	DESCRIPTION	OUT LOOK	SIZE	NO
1	HEADBOARD		1	A	BOLT		M8 x 20 MM	8
2	FOOTBOARD		1	B	BOLT		M6 x 30 MM	20
3	SIDE RAIL		4	C	BOLT		M6 x 35 MM	8
4	HEADBOARD LEGS		2	D	BOLT		M6 x 50 MM	8
5	FOOTBOARD LEGS		2	E	ALLEN KEY		100 MM	1
6	SIDE RAIL LEGS		2	F	ALLEN KEY		70 MM	1
7	SIDE RAIL SUPPORT WOOD		4	G	SCREW		32 MM	8
8	SLAT		4	H	SPRING WASHERS		M6 X 11 MM	6
9	SUPPORT LEG		8	I	FLAT WASHERS		M6 X 19 MM	8
				J	ADJUSTER		35 MM	8

Tools Required (not provided)	
DESCRIPTION	OUT LOOK
PHILLIPS SCREWDRIVER	

STEP 1

Attention: Zip the black non-woven fabric after take out the parts !!

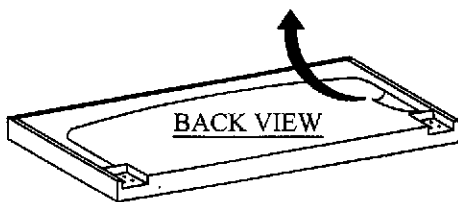

Unzip the black non-woven fabric on the back of headboard and take out all the parts out.

STEP 2

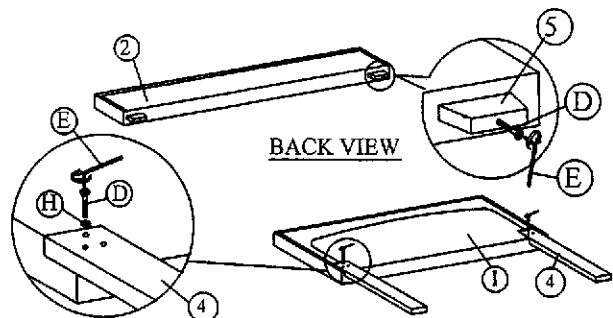

Fix the headboard and footboard with legs as shown.