

ASSEMBLY INSTRUCTIONS

GROUP NO. : 8970/8974

ITEM NO : 8970-W WEDGE

8974-W WEDGE

PAGE: 2 OF 2

Step 2:

Assemble all the components

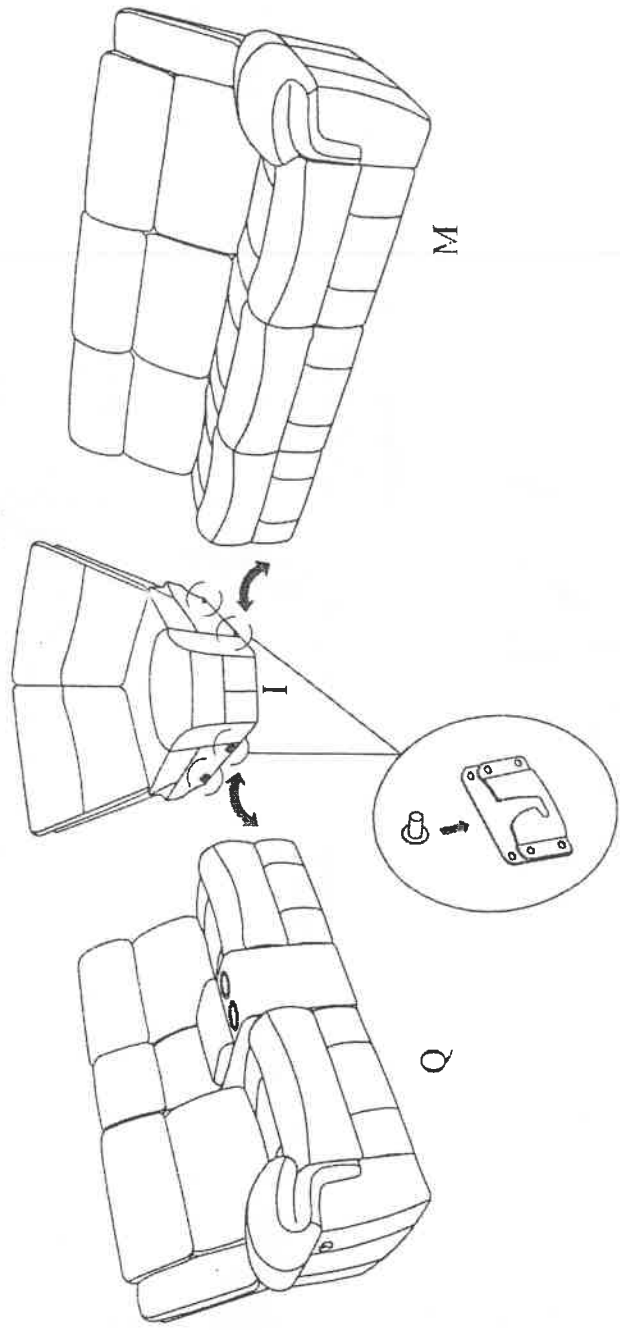

Step 3:

Assembly product is completed

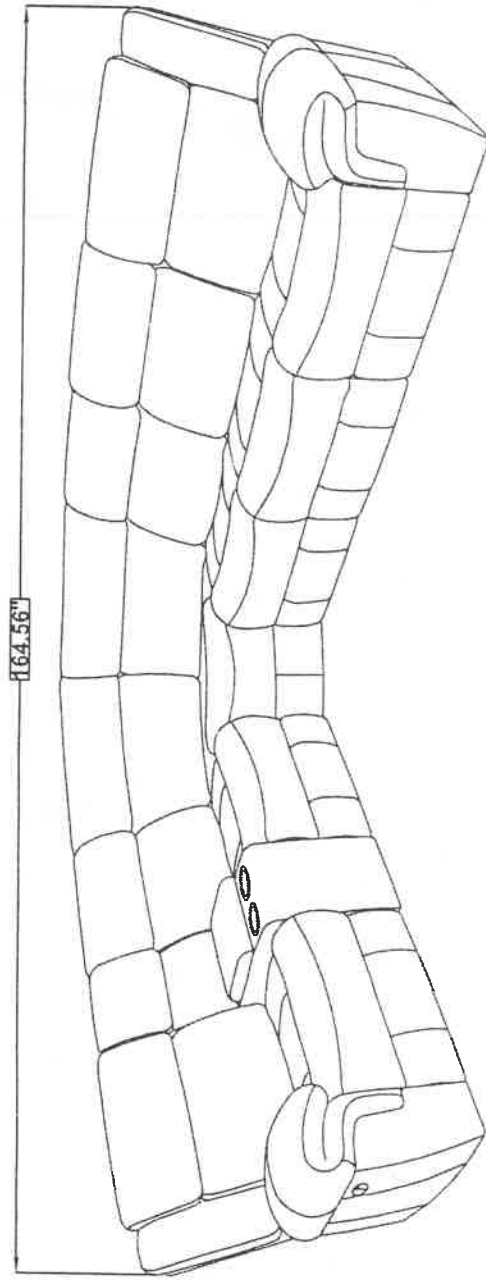

Cleaning instructions: Clean with the soft cloth

Made in Vietnam

ASSEMBLY INSTRUCTIONS





GROUP NO. : 8970/8974

ITEM NO : 8970-W WEDGE

8974-W WEDGE

PAGE: 1 OF 2

PARTS LIST:

NO.	DESCRIPTION	SKETCH	QTY
I	Wedge Seat Base		1 PC
J	Left Backrest		1 PC
K	Right Backrest		1 PC
Q	LAFCL Loveseat		1 PC
M	RAFS Sofa		1 PC

Important note:

1. Carefully open and break seal of bag for backrest and seat cushions. Please let cushions fully expand for 24 HRs before putting seat covers on seat cushions.
2. After expansion insert seat cushion into seat cover and carefully zip closed.

Step 1:

Attach Left Backrest (J) and Right Backrest (K) to the Wedge Seat Base (I)

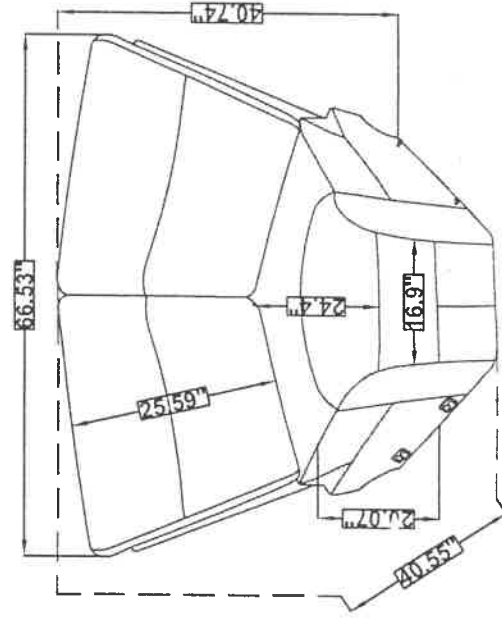
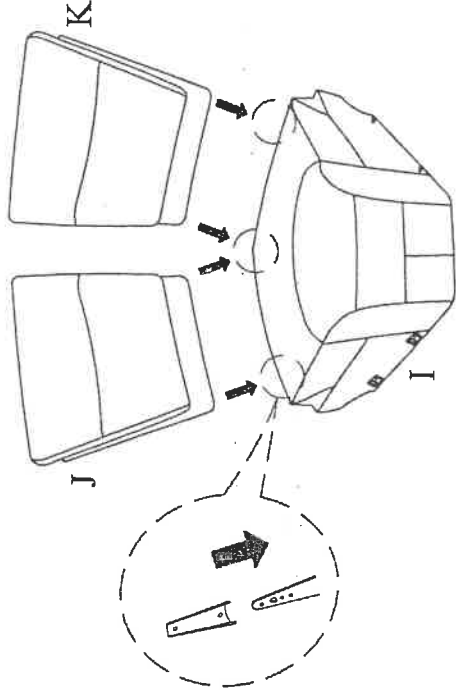

Cleaning instructions: Clean with the soft cloth

Made in Vietnam