

**B184/B185 Twin/ Full/Queen Bed
Assembly Instructions
Contains One Bed and Hardware**

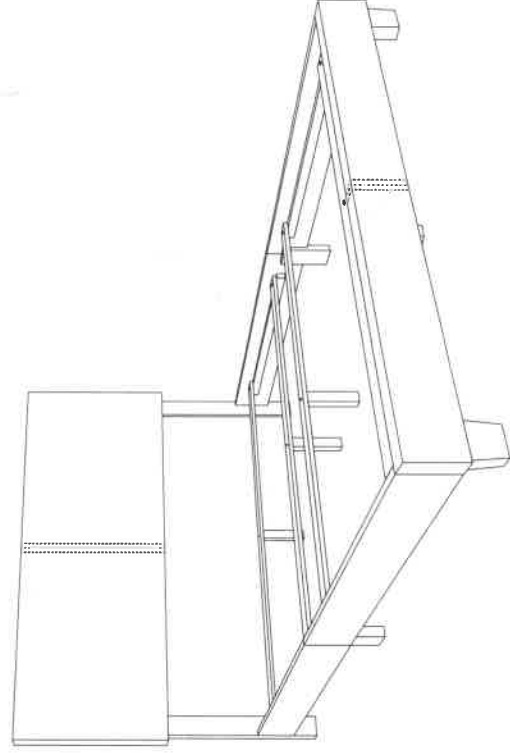

IMPORTANT NOTE:

For customer support please call: 314-993-2693
Carefully remove all the parts from the box. Arrange on a flat surface and verify you have all of the following parts and hardware

TOOLS REQUIRED:
Phillips Screwdriver

PARTS LIST

A. Headboard (1 pc) **B. Headboard Legs (2 pcs)** **C. Side Rail (4 pcs)**



D. Footboard (1 pc)



E. Side Rail Support Leg (2 pcs)

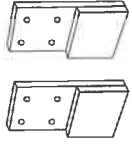

F. Center Leg (4 pcs)

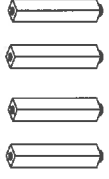

G. Footboard Legs (2 pcs)

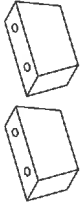

H. Wood Slat (4 pcs)

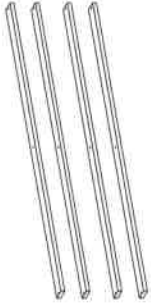

I. Side Rail Slat Support (4 pcs)



HARDWARE LIST

1. 20mm Bolt (8 pcs)



2. Flat Washer (14 pcs)

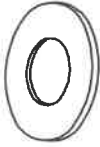

3. Spring Washer (14 pcs)



4. Wood Dowel M8 (4 pcs)



5. 30mm Bolt (12 pcs)



6. 50mm Bolt (4 pcs)

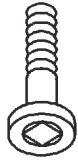

7. 45mm Bolt (6 pcs)

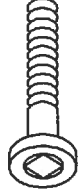

8. 70mm Bolt (2 pcs)

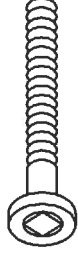

9. 32mm Screw (8 pcs)



10. Barrel Nut M6 (4 pcs)



11. Small Hex Key (1 pc)



12. Large Hex Key (1 pc)



13. 25mm Bolt (8 pcs)



ASSEMBLY INSTRUCTIONS

STEP 1

Attach headboard legs(Part B) to the headboard(Part A) using three 50mm bolts (Part 7) and three spring washer(Part 3) and three flat washer (Part 2) per legs. Secure tightly using small hex key(Part 11).

This headboard is adjustable. To make the Headboard taller (47" from floor to top of headboard), attach the headboard legs to the bottom 3 holes. To make the headboard shorter (43" from floor to top of headboard), attach the headboard leg to the top 3 holes.

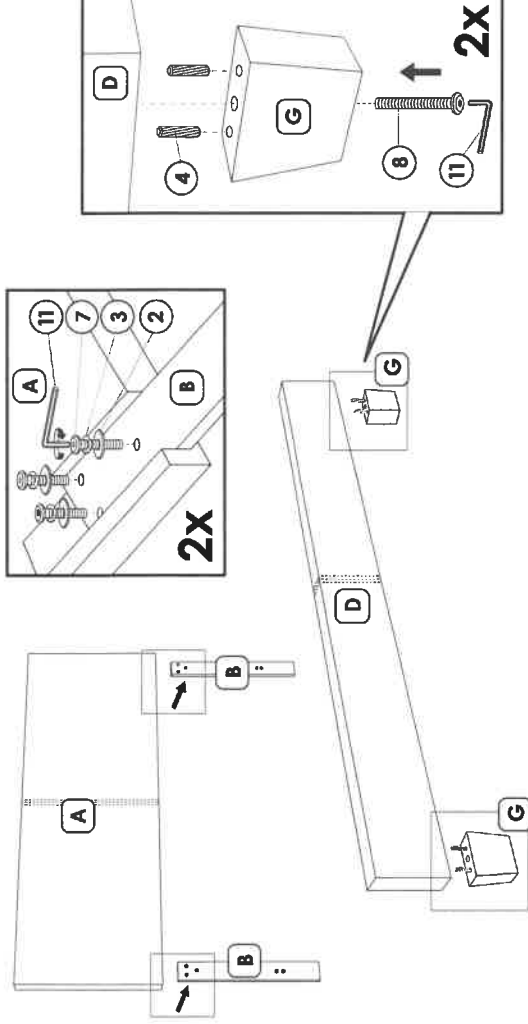

Attach the footboard legs(Part G) to the footboard(Part D) using two wood dowel M8(Part 4) and one 70mm bolts(Part 8) and small hex key(Part 11). Secure tightly.

STEP 2

Attach the side rail legs(Part E) to the side rails(Part C) using 30mm bolts (Part 5), four spring washer(Part 3) with four flat washer(Part 2). Tighten using small hex key(Part 11).

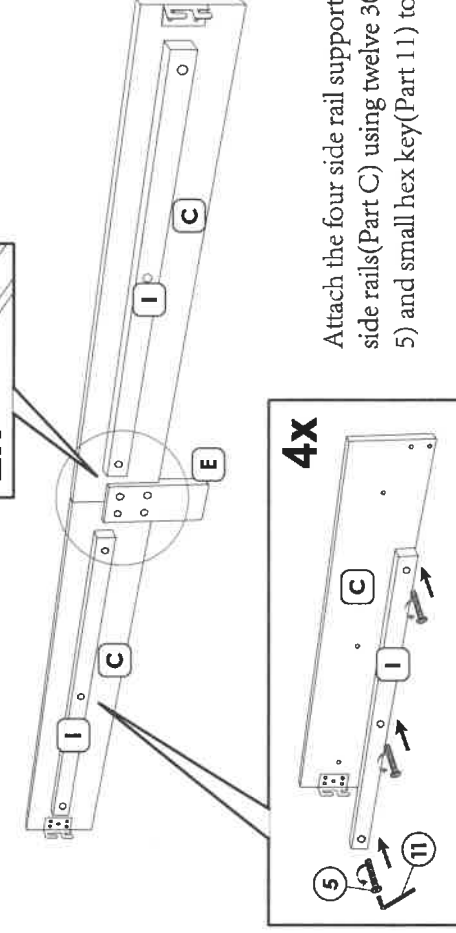

Attach the four side rail supports(Part I) to the side rails(Part C) using twelve 30mm bolts(Part 5) and small hex key(Part 11) to tighten the bolts.

ASSEMBLY INSTRUCTIONS

STEP 3

Attach the eight 20mm bolts (Part 1) to the headboard leg (Part B) and footboard (Part D) using the large hex key (Part 12). Do not tighten.

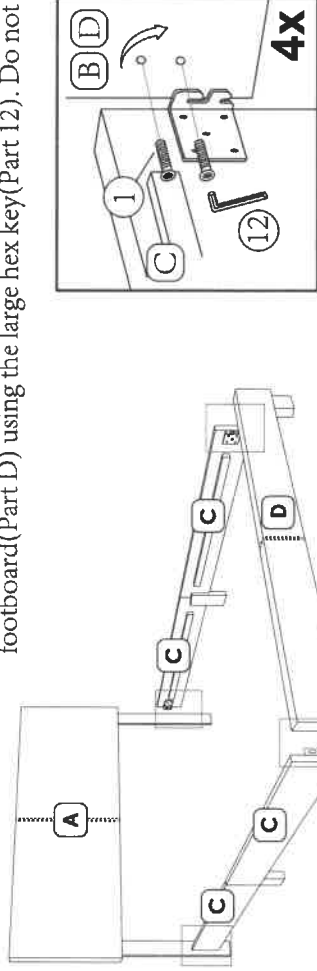

Attach the complete side rail to headboard (Part A) and footboard (Part D) by sliding the side rail brackets onto the bolts on the headboard legs (Part B) and footboard (Part D). Do not tighten yet.

STEP 4

Attach four center leg (Part F) to the slats (Part H) using 50mm bolt (Part 6). Tighten the bolt using small hex key (Part 11). Repeat the step for all four support leg.

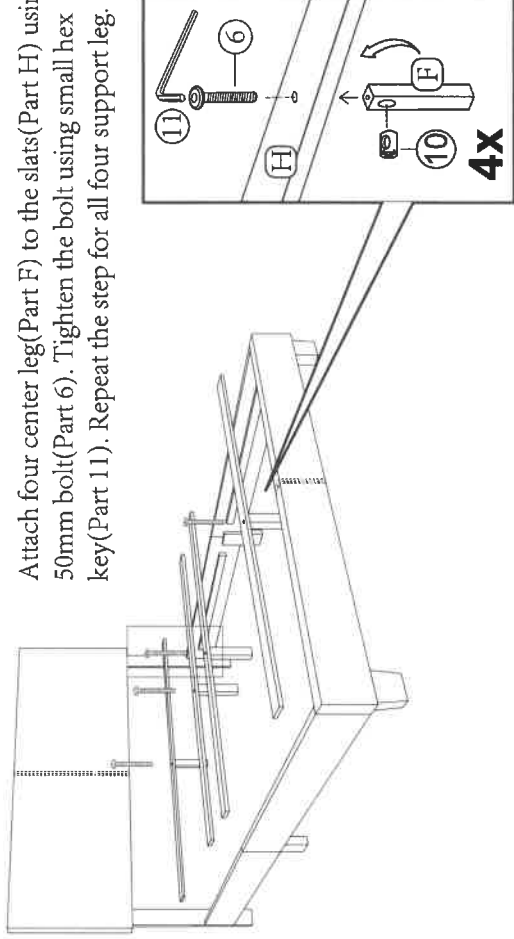

STEP 5

Place the four slats into the bed as shown. Tighten the bolts on the headboard legs and footboard using large hex key (Part 12). Secure the 4 slats using eight screws (Part 9) and a Phillips Screwdriver. Your bed is now set up and ready for use.

