

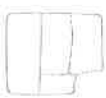

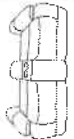

Thank you for purchasing this quality product.

Please read instructions carefully prior to assembly.

Check carefully for small parts which may have come loose during transportation inside all the boxes. Remove from boxes and place all parts and components on soft surface such as carpet, blanket or furniture pad. Identify and verify all parts and hardware as specified below.

PARTS LIST:

NO.	DESCRIPTION	OUTLOOK	SIZE	QT.	NO.	DESCRIPTION	OUTLOOK	SIZE	QT.
1	LAF BACK CUSHION		30.7*9.8*29.5	1	4	LOVESEAT SEAT BASE		75*32.2*20	1
2	CONSOLE BACK (IN THE BOTTOM OF CONSOLE)		12.5*9.8*29.5	1	5	POWER ADAPTER WITH POWER CORD (LOCATED AT IN THE BACK ON THE SIDE OF SEAT BASE)			1
3	RAF BACK CUSHION		30.7*9.8*29.5	1					

Assembly Tips:

This assembly may require additional help (2 person set up)

STEP 1

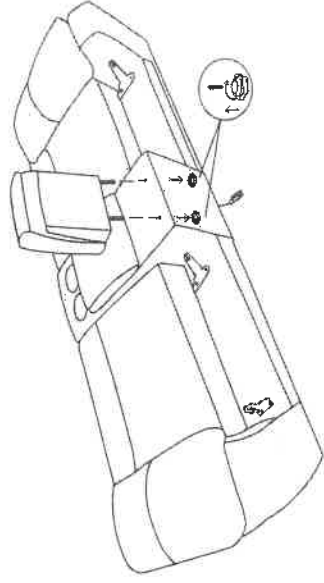

The console back is packed inside the console bottom.

STEP 3

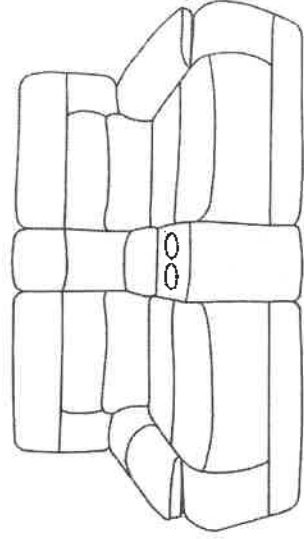

STEP 2

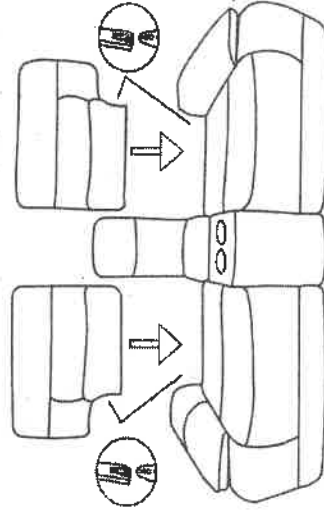

Install back cushions(1)(3) on the sofa seat base.

STEP 4

